

# Flow indicators type TIVG

for controlling the flow of fluids  
in pipes

Catalogue SK 66-1 E Edition 3 June 1989

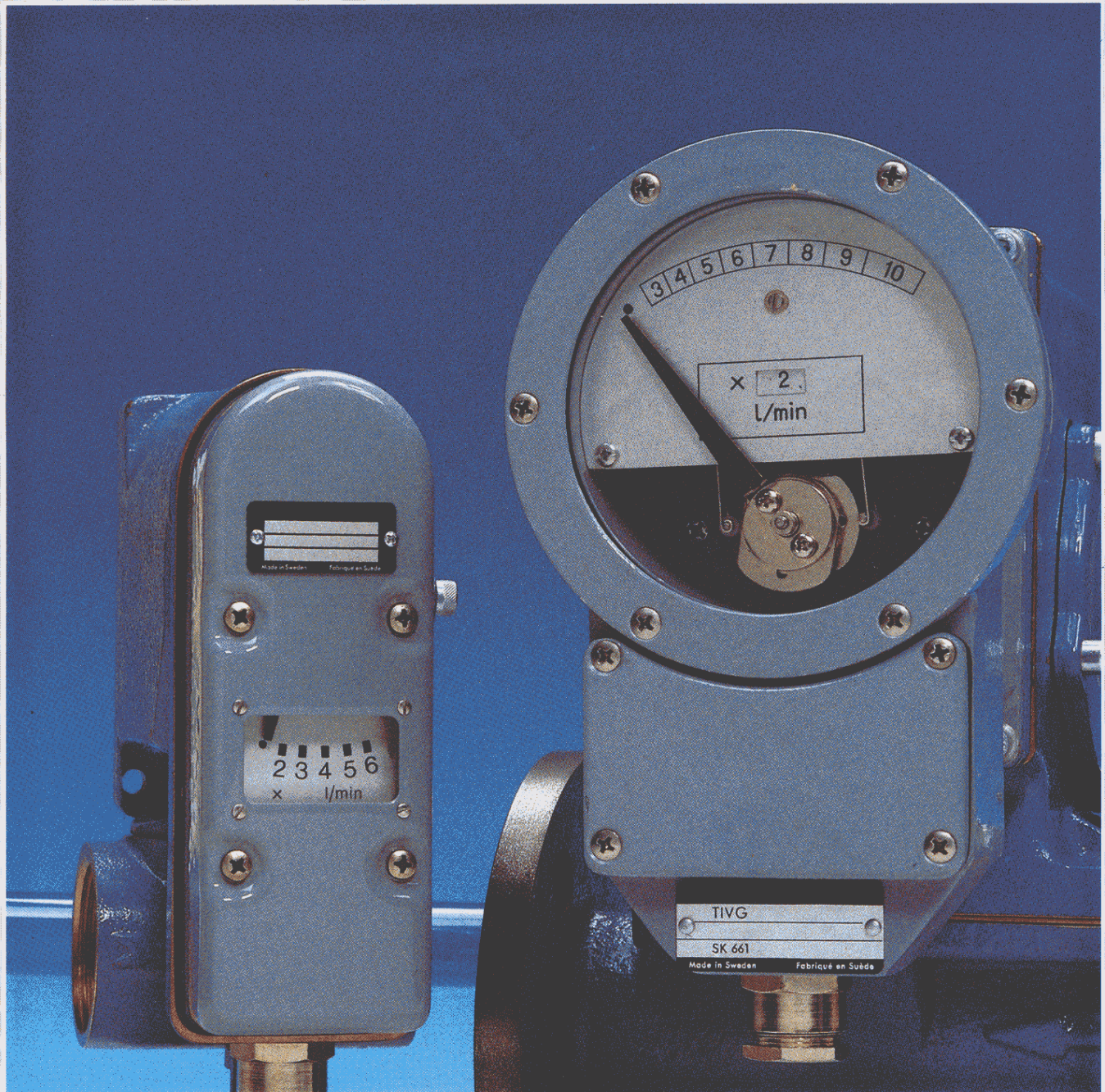

# ELETTA

ELETTA AB  
BOX 5084, S-141 05 HUDDINGE, SWEDEN  
TELEPHONE +46 8 603 07 70  
TELEFAX +46 8 646 10 40



## Alphabetical index

---

	Page		Page
<b>Applications</b>	3	<b>Review</b>	3
<b>Cable area</b>	8	<b>Scale</b>	6
<b>Contact unit</b>	6, 8	<b>Scale constant</b>	4, 5, 6
<b>Degree of protection</b>	8	<b>Special orifice plate</b>	4
<b>Diagrams</b>	10	<b>Standards</b>	8
<b>Dimensions</b>	9	<b>Static pressure</b>	8
<b>Finish</b>	6	<b>Technical data</b>	8
<b>Flange connection</b>	6	<b>Temperature of liquid</b>	8
<b>Function</b>	7	<b>Thread connection</b>	6
<b>Index of Cat.Nos.</b>	11	<b>Versions</b>	6
<b>Measuring range</b>	4, 5	<b>Versions, special</b>	4
<b>Membrane</b>	6, 8	<b>Working range</b>	4, 5
<b>Mounting alternatives</b>	4, 5, 7		
<b>Ordering example and ordering table</b>	4, 5		
<b>Ordering particulars</b>	4		
<b>Orifice plate</b>	4		
<b>Orifice plate housing</b>	6		
<b>Overload</b>	8		
<b>Pressure gauge housing</b>	6		
<b>Pressure loss</b>	8		

Dimensions in mm. The design, data and dimensions are subject to modification without notice.

<b>Contents</b>	
<i>Ordering table</i>	4
<i>Description</i>	6
<i>Technical data</i>	8
<i>Dimensions</i>	9
<i>Diagrams</i>	10

Type TIVG

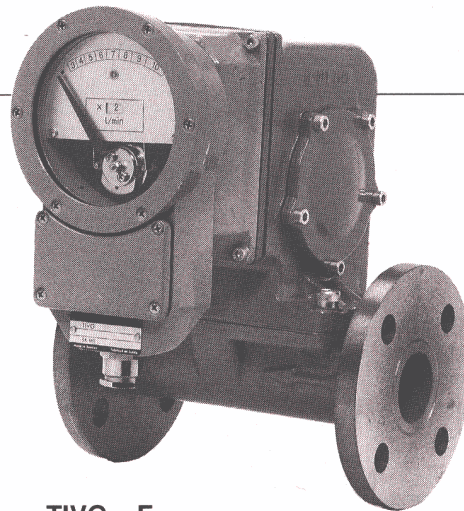
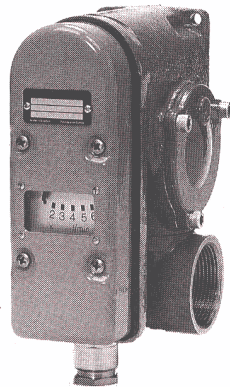

Type, size	TIVG ..R	TIVG ...F
Sizes	15, 25, 40	15, 25, 40, 50, 65, 80, 100, 125, 150, 200, 250, 300, 350, 400
Connection	Thread	Flange
For liquid type	Water, oil	Water, Oil
Nominal working range	0,25 — 175 l/min See the ordering table	9 — 13500 l/min See the ordering table
Maximum measuring range	0,2 — 210 l/min See the ordering table	4,5 — 15000 l/min See the ordering table
Max. temperature of liquid	90 °C	90 °C
Max. static pressure	1 MPa (≈10 bar)	1 MPa (≈10 bar)

### Applications

The flow indicator is a protective device which checks that a given flow of a liquid in a pipe system is the desired rate. The indicator can also be used for control purposes, often in combination with float switches, for stopping and starting pumps. The scale on the indicator is graduated in litres/min. A make-and-break contact is actuated when the flowrate of

the liquid deviates from the set value. This contact can be used, for example, for switching on a warning lamp or an acoustic signal, or for starting or stopping pumps. The indicator is designed for installation in the piping system and no holes are required in the pipe wall for the sensing body. The indicator can supervise

the flow of coolant in transformers, induction coils of furnaces, generators, diesel engines and compressors. It can supervise the supply of fuel oil to central heating boilers, and lubricating oil to gear units and bearings, or the flow of liquids in a water treatment plant. It can cope with almost anything that flows, high and low viscous liquids, contaminated

or clean, from small quantities of 0,5 litre per minute to large quantities of more than 10000 litres per minute.

**TIVG for thread connection — two contact unit**

Type TIVG	For liquid type	Nominal working range l/min	Maximum measuring range l/min	Scale constant	Cat.No.	Weight kg
15R	Water and oil	0,25—0,5	0,2—0,6	0,1	SK 661 003-AA	3,9
		0,5—1	0,4—1,2	0,2	003-AB	3,9
		1—2	0,8—2,4	0,4	003-AC	3,9
		2—4	1,6—4,8	0,8	003-AD	3,9
		4—7,5	3—9	1,5	003-AE	3,9
		6,5—12,5	5—15	2,5	003-AF	3,9
		12,5—25	10—30	5	003-AG	3,9
25R-1	Water	20—40	16—48	8	SK 661 004-AA	4,2
25R-2	Oil				004-AB	4,2
25R-3	Water	30—60	24—72	12	SK 661 004-BA	4,2
25R-4	Oil				004-BB	4,2
25R-5	Water	50—100	40—120	20	SK 661 004-CA	4,2
25R-6	Oil				004-CB	4,2
40R-1	Water	50—100	40—120	20	SK 661 005-AA	4,3
40R-2	Oil				005-AB	4,3
40R-3	Water	90—175	70—210	35	SK 661 005-BA	4,3
40R-4	Oil				005-BB	4,3

**Ordering particulars**

When ordering, state the Cat.No. and mounting alternative, see ordering example.

The indicator is to be selected for the nominal working range, l/min. When the working ranges overlap each other, it may be advisable to select that which has the lower range, to give maximum pointer deflection if the liquid being measured clogs the pipe.

Another angle between the orifice plate housing and the pressure gauge housing (even an inclined angle) can be easily arranged afterwards.

**The following can be obtained on request:**

- Special orifice plate.  
Note that orifice plates for flow-rates greater than the highest value given in the ordering table, cannot be fitted. On the other hand, however, plates for smaller measuring ranges can be fitted, e.g., if the existing indicator is to be used for other purposes. In such cases, the scale constant must also be changed.
- Flow indicators arranged for 2 MPa (≈20 bar) static pressure.

**Mounting alternatives TIVG ..R**

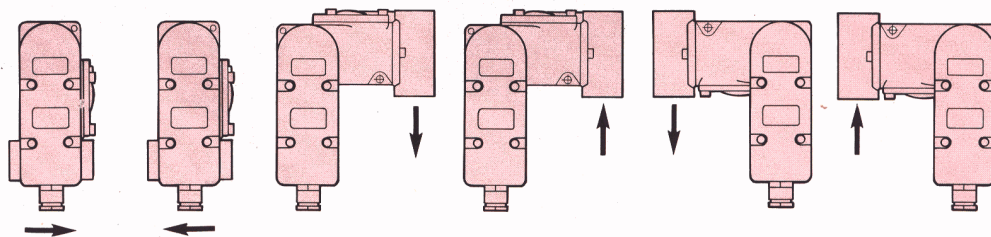

**Alt. 1**  
Horizontal pipe.

**Alt. 2**

**Alt. 3**  
Pressure gauge housing on the left of a vertical pipe.

**Alt. 4**

**Alt. 5**  
Pressure gauge housing on the right of a vertical pipe.

**Alt. 6**

**For the flanged version**

(see next page, TIVG ..F):

- Orifice plate housing of copper alloy instead of cast iron.

**Ordering example**

1. Flow indicator mounting in horizontal pipe, nominal working range 2—4 l/min.  
**Order: SK 661 003-AD + Alt 1**
2. Flow indicator for mounting with the pressure gauge housing on the left of a vertical pipe, nominal working range 420—630 l/min. For oil.  
**Order: SK 661 0144 + Alt 4**



## TIVG for flange connection — two contact unit

Type TIVG	For liquid type	Nominal working range l/min	Maximum measuring range l/min	Scale constant	Cat.No.	Weight kg
15F	Water and oil	9—13,5	4,5—15	1,5	SK 661 0120	14
		12—18	9—20	3	0121	14
		15—27	9—30	3	0122	14
25F-1	Water	25—45	15—50	5	SK 661 0123	15
25F-2	Oil				0124	15
25F-3	Water	42—63	21—70	7	SK 661 0125	15
25F-4	Oil				0126	15
25F-5	Water	60—90	30—100	10	SK 661 0127	15
25F-6	Oil				0128	15
40F-1	Water	90—135	45—150	15	SK 661 0129	17
40F-2	Oil				0130	17
40F-3	Water	120—180	60—200	20	SK 661 0131	17
40F-4	Oil				0132	17
50F-1	Water	120—180	60—200	20	SK 661 0133	18
50F-2	Oil				0134	18
50F-3	Water	180—270	90—300	30	SK 661 0135	18
50F-4	Oil				0136	18
65F-1	Water	180—270	90—300	30	SK 661 0137	19
65F-2	Oil				0138	19
65F-3	Water	250—450	150—500	50	SK 661 0139	19
65F-4	Oil				0140	19
80F-1	Water	250—450	150—500	50	SK 661 0141	21
80F-2	Oil				0142	21
80F-3	Water	420—630	210—700	70	SK 661 0143	21
80F-4	Oil				0144	21
100F-1	Water	420—630	210—700	70	SK 661 0145	23
100F-2	Oil				0146	23
100F-3	Water	600—900	300—1000	100	SK 661 0147	23
100F-4	Oil				0148	23
125F-1	Water	900—1350	450—1500	150	SK 661 0149	25
125F-2	Oil				0150	25
125F-3	Water	1200—1800	600—2000	200	SK 661 0151	25
125F-4	Oil				0152	25
150F-1	Water	1200—1800	600—2000	200	SK 661 0153	28
150F-2	Oil				0154	28
150F-3	Water	1800—2700	900—3000	300	SK 661 0155	28
150F-4	Oil				0156	28
200F-1	Water	2400—3600	1200—4000	400	SK 661 0159	36
200F-2	Oil				0160	36
250F-1	Water	3000—4500	1500—5000	500	SK 661 0161	45
250F-2	Oil				0162	45
250F-3	Water	3600—5400	1800—6000	600	SK 661 0163	45
250F-4	Oil				0164	45
300F-1	Water	4200—6300	2100—7000	700	SK 661 0165	49
300F-2	Oil				0166	49
300F-3	Water	5400—8100	2700—9000	900	SK 661 0167	49
300F-4	Oil				0168	49
350F-1	Water	7200—10800	3600—12000	1200	SK 661 0169	100
350F-2	Oil				0170	100
400F-1	Water	9000—13500	4500—15000	1500	SK 661 0171	115
400F-2	Oil				0172	115

## Mounting alternatives TIVG ...F

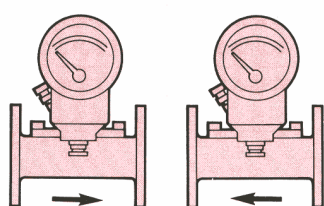

Alt. 1

Horizontal pipe.

Alt. 2

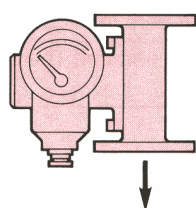

Alt. 3

Pressure gauge housing on the left of a vertical pipe.

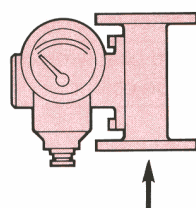

Alt. 4

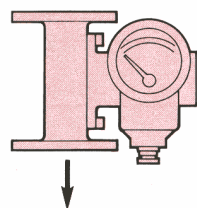

Alt. 5

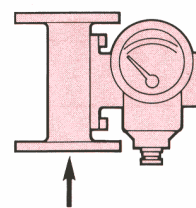

Alt. 6

Pressure gauge housing on the right of a vertical pipe.

## Versions

The indicator is available in two versions, one with the orifice plate housing threaded to suit standard threaded pipes and the other with the housing flanged. The two versions are illustrated in the adjacent figure. Refer to the technical data on page 8 regarding pipe and flange standards.

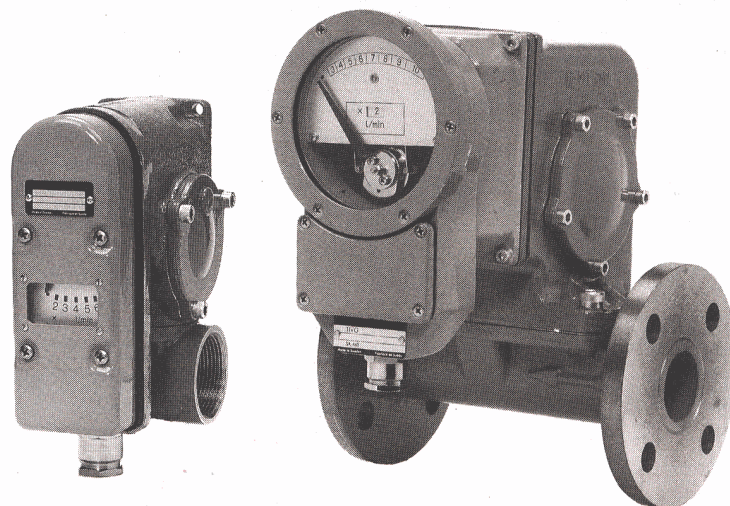

### For thread connection Type TIVG ..R

### For flange connection Type TIVG ...F

#### Pressure gauge housing

Of corrosion resistant copper alloy.

Of corrosion resistant copper alloy. Furnished with valves with which the ducts, to the orifice plate housing, can be closed to enable membrane replacement without interrupting the flow of liquid. The ducts can be cleaned from outside if the valves are first removed.

#### Orifice plate housing

Several sizes, adapted to a series of pipe bores. See dimensions on page 9.

Of corrosion resistant copper alloy.

Of cast iron. On request, of copper alloy.

#### Scale

Multiple (scale constants) adjusted prior to delivery.

Graduated 2...6 × litre/min.

Graduated 3...10 × litre/min.

#### Contact unit

With single-pole instantaneous change-over contact.

Two contact units.

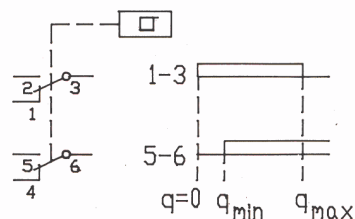

Individually adjustable to change over at scale markings 2-6 inclusive. Set to scale markings 2,5 and 5,5 respectively. Difference between changing and return approx. 0,2 scale division.

Two contact units.

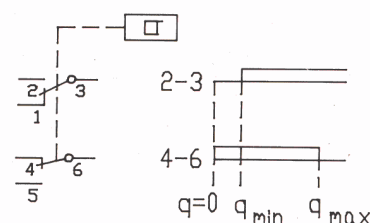

Individually adjustable to change over at scale markings 4-10 inclusive. Set to scale markings 4 and 10 respectively. Difference between changing and return approx. one scale division on indicating position 4 and approx. 0,5 scale division on indicating position 10.

#### Membrane

The membrane is of fabric-reinforced rubber, resistant to the most commonly existing liquids up to a temperature of 90 °C.

The membrane moves against a support when fully deflected and it can therefore resist pressures up to 1 MPa.

The pressure gauge housing is fitted with a cover through which the membrane can be inspected and replaced. The indicator need not therefore be removed from the pipe. The indicator is designed to prevent the liquid from making contact with the bearings.

#### Finish

Primer and blue two-component enamel. The front of the pressure gauge housing is in grey-blue colour.



**Function**

The liquid flows through an annular ring located inside the indicator, which causes a drop in the pressure, the magnitude of which is dependent upon the quantity of the through-flowing liquid. The pressure drop influences an actuator which, in turn, acts upon a pointer that indicates the rate of flow on a scale. Two contact devices are influenced alternately when adjusted values of the flow are exceeded or dropped. Indication is dependent only on the rate of flow. It is independent of the static pressure. To a great extent, it is practically unaffected by the viscosity of the liquid and, consequently, the reading will also be correct for liquids which change their viscosity in service, e.g., oil which becomes thinner the warmer it becomes. Changes in density have no significant influence. The indicator is almost entirely insensitive to sludge and other impurities which can be present in river or lake water after first-stage filtering.

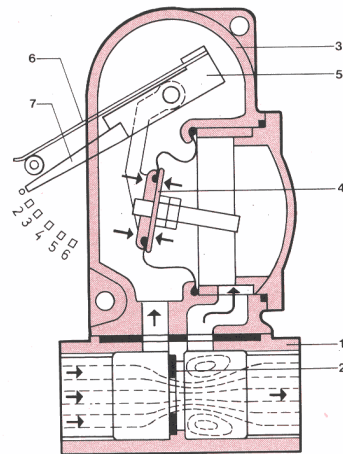

TIVG ...R

- 1 Orifice plate housing
- 2 Orifice plate
- 3 Pressure sensitive device housing
- 4 Membrane
- 5 Actuator
- 6 Spring
- 7 Pointer

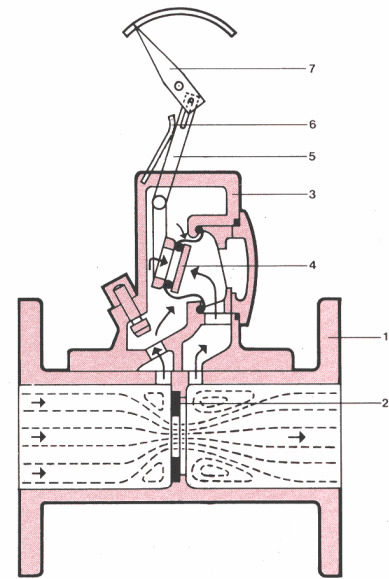

TIVG ...F

**Alternative mounting arrangements**

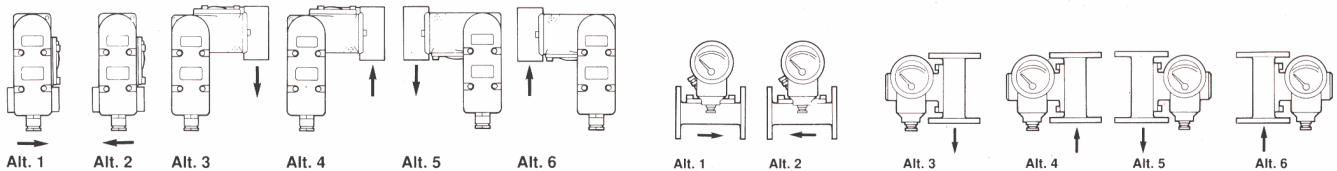

The flow indicators can be supplied with the orifice plate housing fitted in alternative positions relative to the pressure gauge housing, so that the scale will always be correctly oriented irrespective of the direction of the pipe. The indicators can be installed in any desired position.

The direction of flow is indicated by an arrow located on the orifice plate housing. The indicators can also be adapted to pipes which run in directions other than the vertical and horizontal.

The indicators are installed by connecting them directly to the pipe in which the flowrate is to be measured. No additional seals are required. The indicators are relatively insensitive to disturbances in the flow of the liquid but if the disturbances are excessive, the pointer may fluctuate causing the contact units to issue unjustified signals.

To avoid disturbances, the pipe should be straight and without valves for a distance of 10—20 times the pipe diameter, ahead of the indicator. However, a

pipe bend can be placed immediately after the indicator if the flowrate of the liquid is not too high.

The indicator should be connected to steel pipes acc. to the given standards on page 8, Technical data. Faulty readings may result from using pipes of divergent diameters.

The system in which the indicator is fitted should have valves so that the flow can be started gradually to prevent the indicator being damaged by a sudden surge. The flow cannot be set to the desired va-

lue. Slide- or gate-valves are used for low flow rates. Seat valves are unsuitable for flow regulation, as the cone does not seal.

If the flow is less than 10 litres per minute the diameter of the valve should not be greater than 3/8" even if the pipe diameter is 1/2". This is because regulation is difficult if the valve is too large.

	Type TIVG ..R	Type TIVG ...F
<b>Connections</b>		
Pipe dimensions acc. to standard	ISO 65: 1981, medium series	ISO 4200: 1985, series E
Pipe threads acc. to standard	ISO 7-1: 1982	—
Pipe flanges acc. to standard	—	ISO 2084: 1974, PN 10
Measuring range	See the ordering table.	See the ordering table.
Overload	The indicator can withstand up to 50 % overload. However, no indication is given for more than the maximum scale value. The pressure losses will increase considerably, approximately as the square of the increase in the rate of flow. Re-occurring overloads are therefore uneconomic and should be avoided.	
Pressure loss	The diagram below shows the approximate residual pressure loss as a function of the deflection of the indicator's pointer.	
	<div style="display: flex; justify-content: space-around;"> <div style="text-align: center;"> <p>Pressure loss kPa</p> <p>Divisions</p> </div> <div style="text-align: center;"> <p>Pressure loss kPa</p> <p>Divisions</p> </div> </div> <p>A= TIVG 15R for 0,2—0,6, 0,4—1,2, 0,8—2,4 and 1,6—4,8 l/min.                      B= TIVG 15R for other measuring ranges, as well as for TIVG 25R and TIVG 40R.</p>	
Max. temperature of liquid	90 °C	90 °C
Max. static pressure	1 MPa (≈10 bar)	1 MPa (≈10 bar)
Max. connectible cable area	4 mm <sup>2</sup>	4 mm <sup>2</sup>
Cable entry. Cable gland for cable with outside diameter	Pr 22,5 8,5—11,5 mm	Pr 22,5 10,5—13,5 mm
Degree of protection of contact unit enclosure, IEC 144	IP 54	IP 67
<b>Contact unit</b>		
Breaking capacity at 250 V AC	5 A	5 A
125 V DC	0,5 A	0,5 A
250 V DC	0,25 A	0,25 A



Type TIVG ..R for thread connection

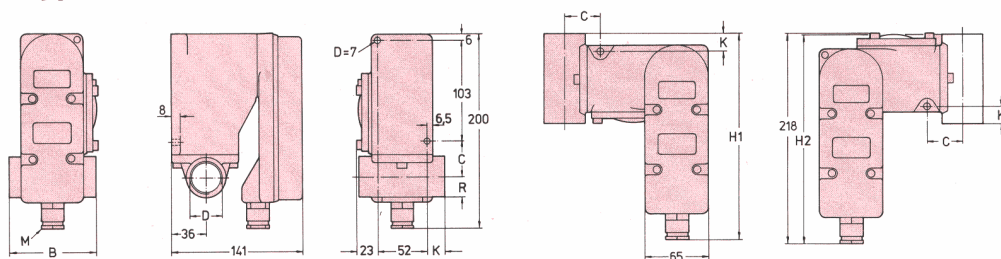

1)

Type TIVG	Nominal bore DN	Pipe thread D	Dimension in mm						
			B	C	H1	H2	K	M	R
15R	15	R 1/2"	70	30	202	206	7	Pr 22,5	14
25R	25	R 1"	90	37	212	216	17	Pr 22,5	21
40R	40	R 1 1/2"	90	44	212	216	17	Pr 22,5	28

1) Standards acc. to Technical data, page 8.

Type TIVG ...F for flange connection

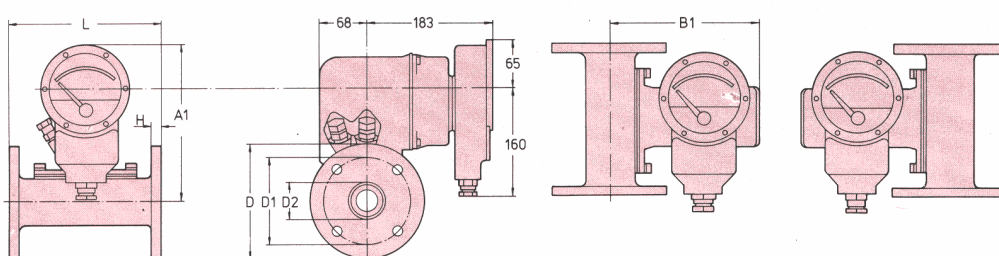

1)

Type TIVG	Nominal bore DN	Dimension in mm.									
		D	D1	D2	D3	n	A1	B1	H	L	N
15F	15	95	65	20	15	4	215	200	14	220	Pr 22,5
25F	25	115	85	32	15	4	220	210	14	220	Pr 22,5
40F	40	150	110	44	18	4	225	215	14	220	Pr 22,5
50F	50	165	125	50	18	4	230	215	14	220	Pr 22,5
65F	65	185	145	70	18	4	240	230	14	220	Pr 22,5
80F	80	200	160	80	18	4	240	230	18	220	Pr 22,5
100F	100	220	180	100	18	8	255	240	18	220	Pr 22,5
125F	125	250	210	125	18	8	265	255	18	220	Pr 22,5
150F	150	285	240	150	22	8	280	265	18	220	Pr 22,5
200F	200	340	295	200	22	8	305	290	20	220	Pr 22,5
250F	250	395	350	250	22	12	330	315	22	220	Pr 22,5
300F	300	445	400	300	22	12	355	340	22	220	Pr 22,5
350F	350	505	460	350	22	16	385	375	30	320	Pr 22,5
400F	400	565	515	400	25	16	410	400	30	320	Pr 22,5

1) Standards acc. to Technical data, page 8.

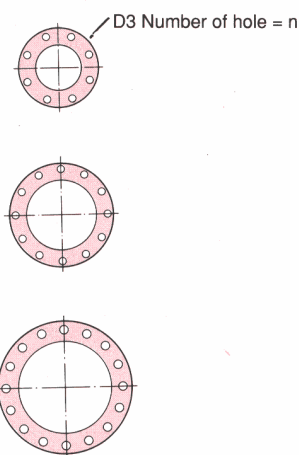

## Type TIVG ..R for thread connection

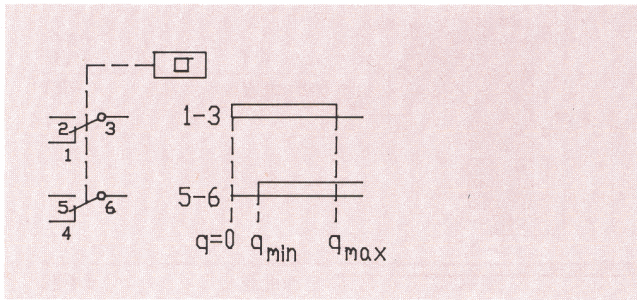

## Type TIVG ...F for flange connection

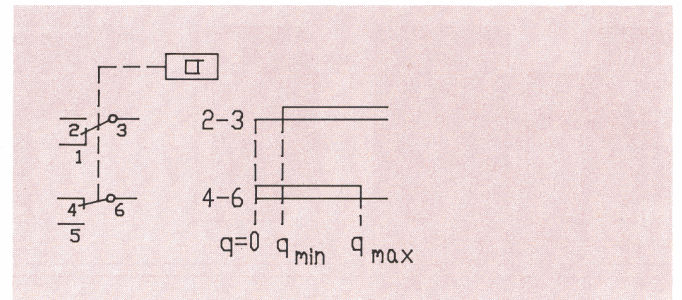



Cat.Nos.	Page
SK 661 003-AA...-AG	4
SK 661 004-AA...-CB	4
SK 661 005-AA...-BB	4
SK 661 0120...0172	5